

WHEEL DATA SHEET FOR STANDARD WHEELS

ORDER
 INQUIRY

WHEEL SIZE: _____ TIRE SIZE: _____

Type of rim: Drop centre 2 piece 3 piece 4 piece 5 piece
 Pneumatic Resilient without components with components

Quantity : _____ Model type: _____ Wheel Number: _____
Part - Number: _____



	Inch:	mm:
RW Rim width:	_____	---
RD Rim diameter:	_____ Ø _____	---
H Nave thickness:	---	_____
A Centre hole:	_____ Ø _____	_____
B Pitch circle diameter:	_____ Ø _____	_____
C Number of holes:	# _____	_____
D Hole dia:	_____ Ø _____	_____
E Countersink dia.:	_____ Ø _____	_____
G Please mark nave position:	_____	

As a reference point please take gutter side or fixed flange side.

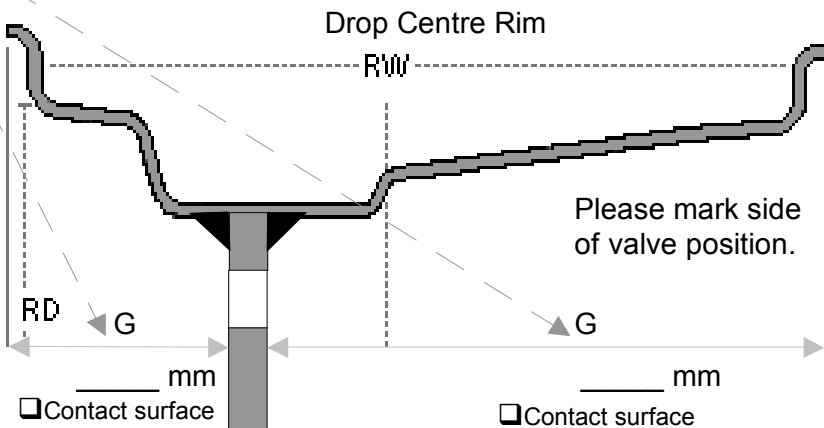
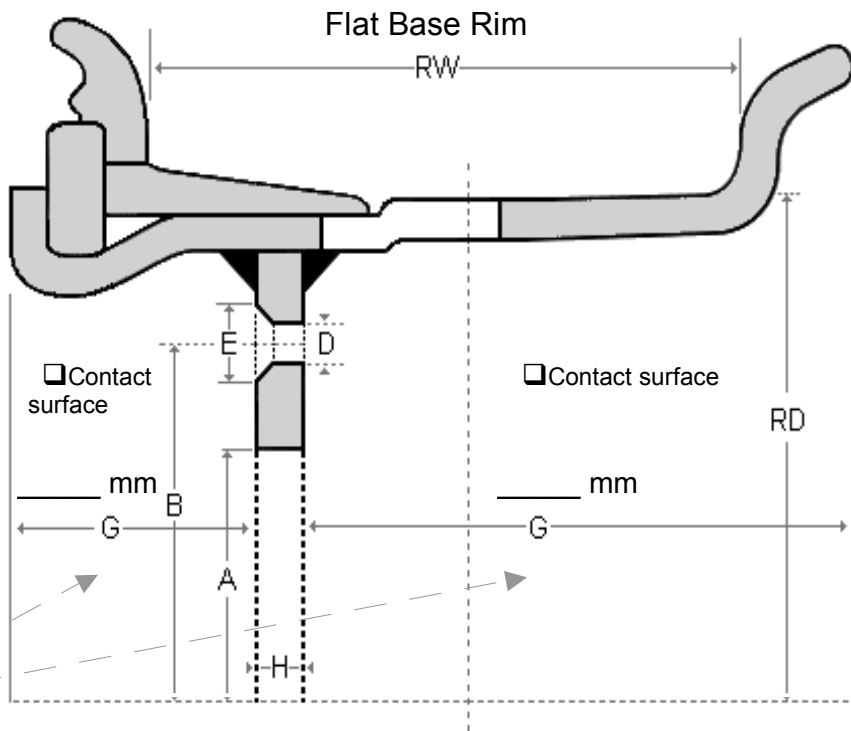
Remarks:

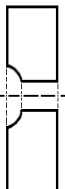
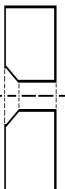

Countersink form: _____ Single or Doube: _____

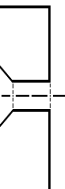
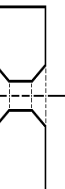
Spherical	Conical	Flat	A or B	B
<input type="checkbox"/>	<input type="checkbox"/>	<input type="checkbox"/>	<input type="checkbox"/>	<input type="checkbox"/>
				

Company name / Contact person